

# INSTALLATION INSTRUCTIONS

No. 1000  
Rev. D  
11-97

## COMPU-FIRE® ELITE 1 SERIES ELECTRONIC ADVANCE Ignition Module Kits

THIS INSTRUCTION SHEET COVERS THE FOLLOWING PART NUMBERS;

P/N	MODULE		DESCRIPTION
20500	HDE-1	DUAL FIRE	SINGLE OR DUAL PLUG
20550	HDE-2	SINGLE FIRE	SINGLE OR DUAL PLUG

### **READ THROUGH THESE INSTRUCTIONS COMPLETELY BEFORE BEGINNING INSTALLATION.**

#### STEP # 1: REMOVE STOCK IGNITION COMPONENTS

#### CONVERTING POINTS IGNITION TO COMPU-FIRE® ELITE 1 IGNITION

Refer to Figure 1.

1. Turn the ignition switch to the "off" position.
2. Disconnect the ground (-) cable from the battery.
3. Remove the optional cover (1), the ignition side cover (2) and gasket (3).
4. Remove the two standoffs (4) and washers (5) that secure the point plate (6) to the ignition housing. Disconnect the wire going to the points and remove the plate assembly.
5. Remove the bolt (7) and the advance assembly (8) and (9) from the engine.

#### CONVERTING LATE 1978-1979 OEM ELECTRONICS TO COMPU-FIRE® ELITE 1 IGNITION

Refer to Figure 2.

6. Turn the ignition switch to the "off" position.
7. Disconnect the ground (-) cable from the battery.
8. Remove the ignition side cover (10), gasket (11) & ignition module (13). Remove the timer plate (17). Remove hex head bolt (14) and advance assembly (18) and (19) from the engine.

#### CONVERTING 1980 AND LATER OEM ELECTRONICS TO COMPU-FIRE® ELITE 1 IGNITION

Refer to Figure 3. NOTE Turn the ignition switch to the "OFF" position. Disconnect the ground (-) cable from the battery.

9. Drill out the rivets (20) in the outer cover (21) with a 3/8" drill bit and remove the outer cover.
10. Remove the inner cover (22) and gasket (23).
11. Remove the two standoffs (24). Disconnect the sensor wire connector from the ignition module. Push the terminals out through the back of the connector housing. This allows the terminals to pass through the hole in the ignition housing when the sensor plate is removed.
12. Remove the sensor plate (26).
13. Remove the bolt (27) securing the rotor (28).
14. Remove the rotor (28).

#### STEP #2: INSTALL THE COMPU-FIRE® ELITE 1 IGNITION COMPONENTS

NOTE: DO NOT use the washers Figure 1 (5), Figure 2 (16) or Figure 3 (25).

15. Clean out the ignition cavity in the cam cover. Replace oil seal if necessary.
16. Refer to FIGURE 4. Secure Compu-Fire Trigger Rotor (36) with the socket head screw (34) and flat washer (35) using blue Loc-Tite® to prevent loosening. Align the locating pin with the notch in the cam. Torque screw to 25 inch pounds. Remove the timing plug from the observation hole. Remove the spark plugs. With the transmission in top gear, roll the bike until the front cylinder TDC timing mark (FIGURE 5) is in the center of the hole. See FIGURE (6). Observe the position of the magnets and the locating pin in the Elite 1 Trigger Rotor. For Big Twins® the locating pin will be positioned as shown in either FIGURE 6A or FIGURE 6B. FIGURE 6A shows the correct position. If the locating pin is in the wrong position (FIGURE 6B), rotate the engine one more revolution which will bring the trigger rotor to the position shown in FIGURE 6A. For Sportster® follow the same procedure using FIGURE 7A and FIGURE 7B.

### **DO NOT MOVE THE ENGINE POSITION UNTIL THE TIMING PROCEDURE IS COMPLETE.**

17. Install the Elite 1 ignition module (33) Figure 4 using the two standoffs (32) just tight enough so that the module can be rotated to set timing. Locate the module with the V notch in the module over the V grooved area in the housing. This groove is at approximately the 7 o'clock position on Big Twins® and the 11 o'clock position on Sportsters®. Refer to FIGURE 8.
18. Carefully thread the cable from the Elite 1 ignition module through the hole in the housing. Leave enough cable to form a neat loop inside the housing to allow for timing adjustment.

#### STEP #3: SET THE IGNITION TIMING

AT THIS POINT THE ELITE 1 IGNITION MODULE STATIC TIMING IS SET USING THE ACCU-RAY FRONT CYLINDER TDC LIGHT. Read steps 19 through 27 completely.

19. **MAKE SURE** the ignition switch is off. RECONNECT BATTERY GROUND CABLE,
20. The RED wire from the Elite 1 module must now be temporarily connected **directly** to the positive (+) battery terminal. **BE CAREFUL NOT TO SHORT THE BATTERY TO GROUND.** Carefully slit the cable jacket about one inch to expose the inner wires. Remove the excess jacket. Strip the red wire only and connect it to the positive (+) battery terminal. **DO NOT** strip any of the other wires.
21. Rotate the Elite 1 ignition module counterclockwise to the full retard position. The ACCU-RAY timing light may be on or off. Use the large disk magnet stack supplied in the hardware kit to **turn** this light on and off to get familiar with it. Place the magnet against the module in the area shown in FIGURE 9. When the side of the magnet with orange dot is facing you the light will turn off. Turning the magnet over will **turn** the light on. Leave the light in the off position.
22. Slowly rotate the Elite 1 module clockwise until the ACCU-RAY front cylinder TDC light just turns on. Steps 21 and 22 may be repeated to insure accurate setting. Tighten standoffs (32) FIGURE 4 at this time.
23. The ignition system is now statically timed.
24. Reinstall the spark plugs.
25. Disconnect the RED wire from the battery.
26. Route the cable to the coil(s) making sure it does not touch hot surfaces. Cut the cable to length. Tighten the cable clamp.
27. Carefully slit the cable jacket to expose the inner wires. Remove the excess jacket.

#### STEP #4: CONNECT WIRES TO THE COIL(S)

**CAUTION!! CONNECTING THE WIRES INCORRECTLY CAN DAMAGE THE ELECTRONICS MODULE.**

COMPU-FIRE® Ignition Systems may be used with any high quality coil with 2 to 3 ohms of primary resistance. Coils with higher resistance may be used, but the ignition energy will be drastically reduced.

The Coil Hook-up is shown in the following figures.

	SINGLE PLUG	DUAL PLUG
MODEL 20500 (DUAL FIRE)	FIGURE 10	FIGURE 11
MODEL 20550 (SINGLE FIRE)	FIGURE 12	FIGURE 13

Note: For tach operation in Single Fire - use part no. 5 1105 tach adapter. Other manufacturers tach adapters are not compatible with Elite 1 Modules and must be removed.

Set ignition timing per factory tune-up procedure. Re-install the ignition side cover(s) and the ignition timing plug into the observation hole. The installation is now complete.

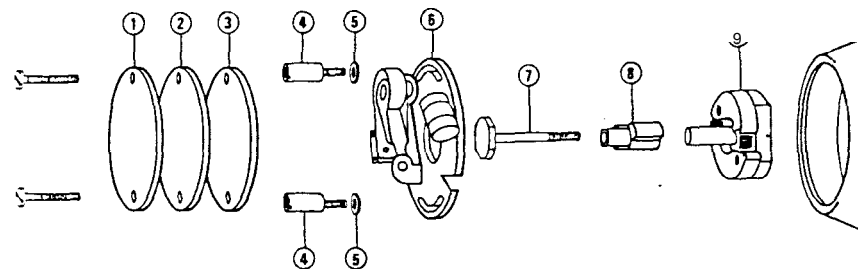

POINTS IGNITION

Figure 1

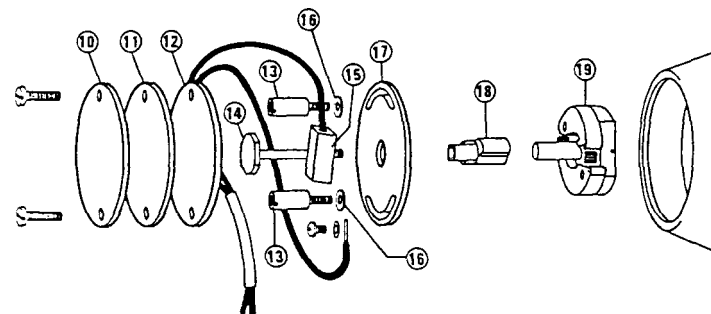

LATE 1978-1979 OEM ELECTRONICS

Figure 2

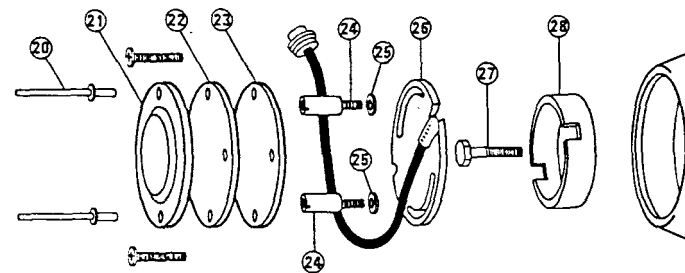

1980 AND LATER OEM ELECTRONICS

Figure 3

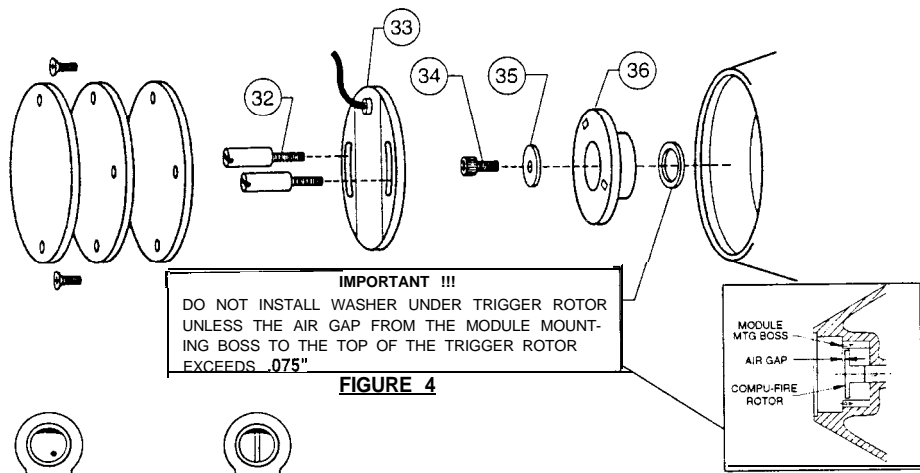

**FIGURE 4**



**EARLY STYLE**



**LATE STYLE**

**FIGURE 5**

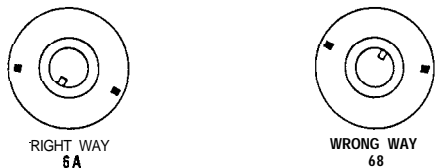

LOCATING PIN POSITION AT T.D.C. FOR BIG TWINS

**FIGURE 6**

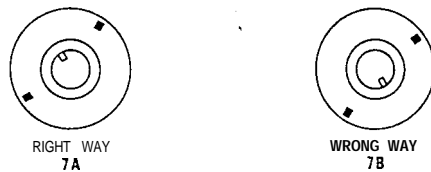

LOCATING PIN POSITION AT T.D.C. FOR SPORTSTERS

**FIGURE 7**



V NOTCH IN 7 O'CLOCK POSITION

**FIGURE 8**

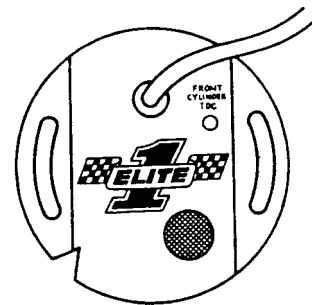

**FIGURE 9**

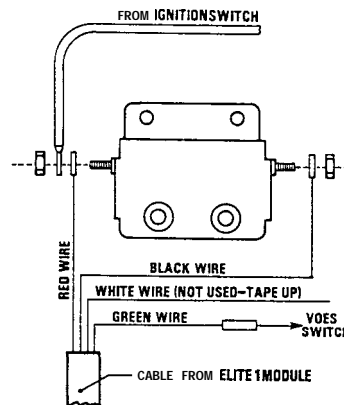

**FIGURE 10**  
**DUAL FIRE**  
**SINGLE PLUG**

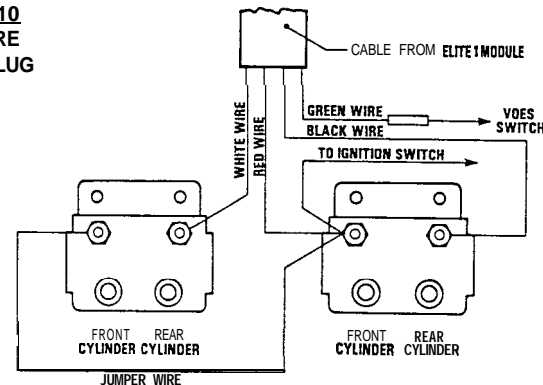

**FIGURE 11**  
**DUAL FIRE**  
**DUAL PLUG**

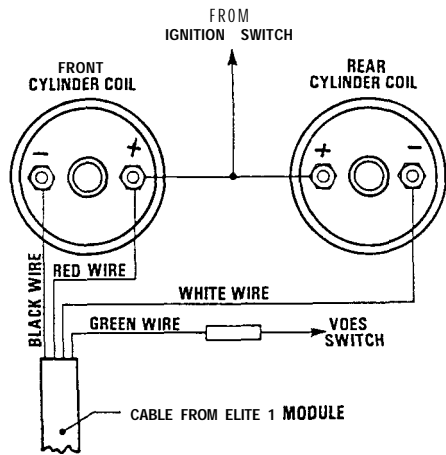

**FIGURE 12**  
SINGLE FIRE  
SINGLE PLUG

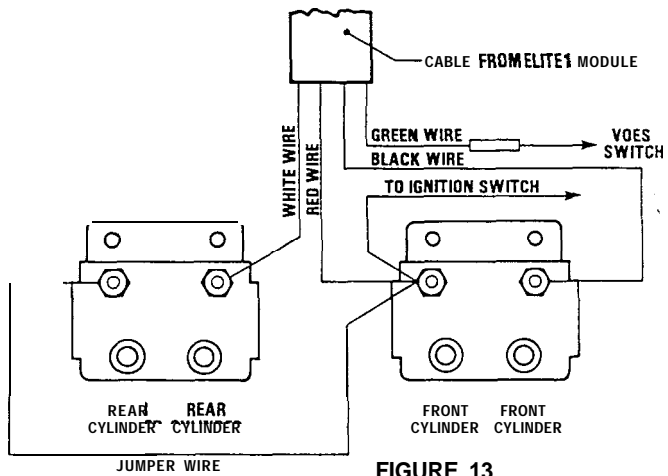

**FIGURE 13**  
SINGLE FIRE  
DUAL PLUG